



The **Egon** taps are a brand new design concept featuring beautifully sculptured rectilinear spouts. Each of the models share the same refined spout design but each offer a variety of different water control solutions. Despite the thin profile spout, water aerators have not been left out and have been cleverly positioned at the rear of the spout so that they are concealed when viewing from the front.

60900

The **60900** has a swiveling spout and single control lever on a very neat platform. This tap is ideal for installing directly on to worktops - especially suited on granite or stainless steel for example.

Ref. 60900
 Chrome **£514**
 Brushed Steel **£657**

Min. 1.0 bar pressure required
 Height 265mm
 Reach 213mm



Egon

The spouts are 40mm wide and only 10mm deep. The water aerators are positioned at the rear of spout thus maintaining an unbroken sleek shape.



60921

Total flexibility with this fellow - the tap can be fitted on the sink or worktop in the traditional manner while the remote control which operates the temperature and water flow can be positioned anywhere (within 700mm of the tap). Perhaps on the wall or even on the unused tap-hole at the front of your sink.

Ref. 60921
 Chrome **£514**
 Brushed Steel **£659**

Min. 1.0 bar pressure required
 Height 384mm
 Reach 213mm



60931

This model has all the flexibility of its brother 60921 but if that wasn't enough this one comes with the ever useful pull-out hand spray complete with on/off lever. It doesn't get any better than this!

Ref. 60931
 Chrome **£795**
 Brushed Steel **£1043**

Min. 1.0 bar pressure required
 Height 384mm
 Reach 213mm



The progressive valve in 'on' position.



60971

A very chic wall mounted version of the Egon with fixed spout and single control lever.

Ref. 60971
Chrome £587
Brushed Steel £778

Min. 1.0 bar pressure required
Reach 221mm

60910

The **60910** has the latest progressive valve installed - simply push the lever up and revolve the central column for temperature control. As with all these models (except 60971) the spout fully swivels for use with multi-bowl sinks.

Ref. 60910
Chrome £655
Brushed Steel £846

Min. 1.0 bar pressure required
Height 384mm
Reach 213mm



60922

Same principal as its single remote control cousin but this time with dual controls. Again the controls can be either wall mounted or fitted in line on the worktop or sink. Maximum distance from tap is 250mm.

Ref. 60922
Chrome £547
Brushed Steel £734

Min. 1.0 bar pressure required
Height 384mm
Reach 213mm



Newform



Water Pressure explained - page 119

Taps

Morpho

The **Morpho** is most definitely the most distinctive tap in our collection. The water really does travel through the little tubes and works just the same as any of our more regular spouted taps. The quality and craftsmanship is typically Newform high so you can be assured of years of astonishing your guests with this unique tap.

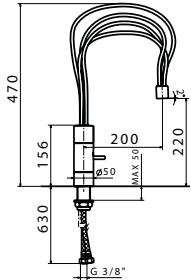

Ref. 61900

Morpho single lever mixer with swivel tap
 Chrome £593
 Brushed Steel £740

Min. 1.0 bar pressure required

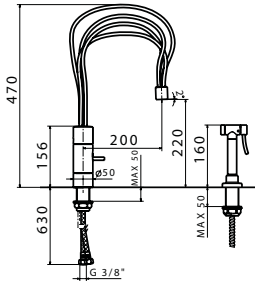

Ref. 61945

Morpho single lever mixer with swivel tap and dishwashing hand shower with stop
 Chrome £832
 Brushed Steel £1009

Min. 1.0 bar pressure required



Time Square

The **Time Square** has taken the classical traditional cross-head mixer tap and added some modern pizzazz. The round and square shapes combine beautifully and have helped create a very handsome and practical tap.

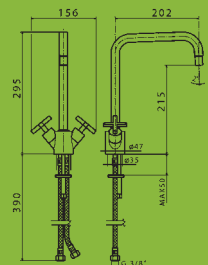

Ref. 8983

Time Square twin cross-head control mixer with swivel tap
 Chrome £295
 Brushed Steel £356

Min. 1.5 bar pressure required

QB

The futuristic **QB** tap is strictly for the most contemporary of kitchens. It swivels a full 160° and the flow and temperature are operated by the a control block on the top of the tap.

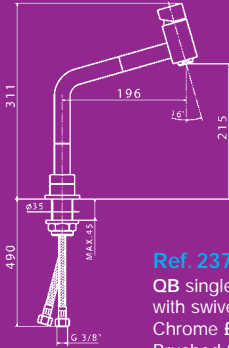

Ref. 2370

QB single control mixer with swivel spout
Chrome £408
Brushed Steel £525

Min. 1.0 bar pressure required

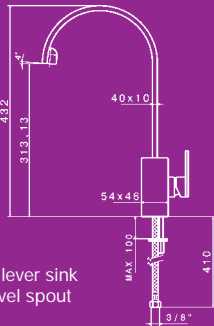

Ref. 61421

D-Rect single lever sink mixer with swivel spout
Chrome £407
Brushed Steel £587

Min. 1.0 bar pressure required

D-Rect

The **D-Rect** taps are unashamedly minimalist featuring beautifully sculptured rectilinear lines. Choosing the D-Rect will really add a touch of class to your kitchen.



Newform



Aerators are factory fitted with each tap and supply a non-splash frothy flow



Water Pressure explained - page 119

Taps



Rotating Spout
The X-Trend 2400 and 2420 have rotating spout ends to direct the water flow laterally.



2400

The original classic minimalist design with the added bonus of a rotating spout end so that water can be directed laterally.

Ref. 2400
Chrome **£251**
Brushed Steel **£296**

Min. 0.5 bar pressure required
Height 263mm
Reach 217mm



2420

A very unusual modern Bridge tap - great for worktop mounting.

Ref. 2420
Chrome **£369**
Brushed Steel **£487**

Min. 0.7 bar pressure required
Height 359mm
Reach 257mm
Tap hole centres 150mm



2460

More commonly found in the States but has now found its way to our shores - wall mounted taps are perfect when worktop space is tight and a Butler sink is being used.

Ref. 2460
Chrome **£334**
Brushed Steel **£438**

Min. 0.5 bar pressure required
Reach 220mm

2430/C

A very sophisticated 3 hole wall mixer with separate hand spray.

Ref. 2430/C
Chrome **£454**
Brushed Steel **£631**

Min. 0.7 bar pressure required
Height 156mm
Reach 306mm
Tap hole centres 150mm



2445

To work alongside your normal mixer tap - a pull-out hand set has become increasingly more popular.

Ref. 2445
Pull-Out Hand Set
Chrome **£394**
Brushed Steel **£455**

Min. 0.7 bar pressure required

2417

A chunky minimalist soap or lotion dispenser with a generous 1/2 litre reservoir.

Ref. 2417
Chrome **£102**
Brushed Steel **£125**

Height 143mm
Reach 153mm

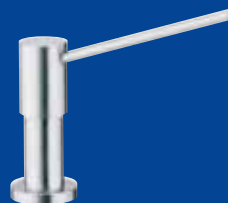



2415

Lots more Pull-Out spray taps around these days - but none so stylish as this one.

Ref. 2415
 Chrome £307
 Brushed Steel £394

Min. 1.0 bar pressure required
 Height 263mm
 Reach 217mm
 Spout Drop 185mm



Backwards & Forwards



Side to Side

X-Trend

These are the **original** minimalist pillar taps manufactured for us by Newform; very high quality taps with nice twist at the end.

Specifications

All Newform taps are manufactured using the best components available. All valves are high tech CD cartridges. All spouts turn to service multi-bowl sinks. All taps are supplied with spout aerators to produce that lovely frothy flow.



Carbon activated and resin composition suitable for hard and soft water areas - removes tastes, odour, dissolved particulates and chemicals.

Ref. AT2002
 Replacement Filter £31

Cold Rinse

2260

Mini X Rinse

A very neat solution for rinsing your vegetables. Install in secondary sink or install along side one of its big brothers.

Ref. 2260
 Chrome £127
 Brushed Steel £158

Min. 0.5 bar pressure required
 Height 130mm
 Reach 90mm



Mini X Little Big Taps

Small but cute. These two little taps are the perfect solution for a secondary sink and food preparation, or if you want to enjoy filtered water at the pull of a lever choose the Mini X filter.

Please note they function with cold water supply only.

Filter Tap



2260F

Mini X Filter

A new development on the Rinse tap with the added bonus of receiving beautiful tasting filtered water at the push of a lever.

Ref. 2260F
 Chrome £220
 Brushed Steel £254

Min. 0.5 bar pressure required
 Height 130mm
 Reach 90mm



2410

Backwards, forwards, side to side, even pressing a button can give you a different spray option - hours of fun can be had directing water around the kitchen with this versatile tap.

Ref. 2410
 Chrome £317
 Brushed Steel £411

Min. 0.7 bar pressure required
 Height 263mm
 Reach 209mm



Water Pressure explained - page 119

Moonytech

A very sophisticated mix of square and round shapes have created the new Moonytech.

8097



This combination of square and round has taken the minimalist style to a new level.

Ref. 8097

Moonytech
 Chrome £354
 Brushed Steel £432

Min. 0.5 bar pressure required
 Height 270mm
 Reach 210mm

8098



If you like the 8097 you will love this with its ever practical pull-out spout.

Ref. 8098

Moonytech Pull-Out
 Chrome £432
 Brushed Steel £504

Min. 1.0 bar pressure required
 Height 276mm
 Reach 210mm

Specifications

All Newform taps are manufactured using the best components available. All valves are high tech CD cartridges. All spouts turn to service multi-bowl sinks. All taps are supplied with spout aerators to produce that lovely frothy flow.



Mini Moon Little Big Taps

Small but cute. These two little taps are the perfect solution for a secondary sink and food preparation, or if you want to enjoy filtered water at the pull of a lever choose the Mini Moon filter. Please note they function with cold water supply only.

Carbon activated and resin composition suitable for hard and soft water areas - removes tastes, odour, dissolved particulates and chemicals.

Ref. AT2002
 Replacement Filter £31



Cold Rinse

8060

Mini Moon Rinse

A very neat solution for rinsing your vegetables. Install in secondary sink or install along side one of its big brothers.

Ref. 8060

Chrome £156
 Brushed Steel £191

Min. 0.5 bar pressure required
 Height 150mm
 Reach 90mm



Filter Tap

8060F

Mini Moon Filter

A new development on the Rinse tap with the added bonus of receiving beautiful tasting filtered water at the push of a lever.

Ref. 8060F

Chrome £244
 Brushed Steel £281

Min. 0.5 bar pressure required
 Height 130mm
 Reach 90mm





9798 PULL OUT

Bend it, shake it, wave it all about !
Choose this one and your have real
spring in your tap.

Ref. 9798
Chrome £452
Brushed Steel £461

Min. 1.0 bar pressure required
Height 460mm
Reach 207mm

Tridis

9789 PULL OUT

If your in the swan neck spout camp
as apposed to the square variety then
this could be the answer.

Ref. 9789
Chrome £384
Brushed Steel £481

Min. 1.0 bar pressure required
Height 460mm
Reach 205mm

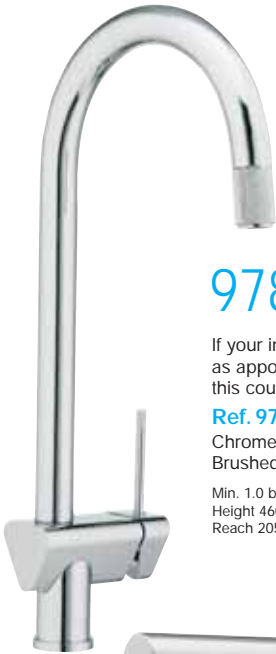

9797 PULL OUT

Good looks as well as enormous
practicality with the 9797's
pull-out spout.

Ref. 9797
Chrome £376
Brushed Steel £469

Min. 1.0 bar pressure required
Height 281mm
Reach 219mm



9796

A splendid mix of shapes combine
to create a little stunner.

Ref. 9796
Chrome £306
Brushed Steel £422

Min. 0.5 bar pressure required
Height 281mm
Reach 219mm



Water Pressure
explained - page 119

X-Trend

Three very elegant taps available in three sizes. Each version includes a pull-out spray.



Pull-out spout extended

Ref. 2453

Chrome Pull-out
£334

Brushed Steel Pull-out
£422

Min. 1.0 bar pressure required
Height - 381mm
Spout Reach - 219mm
Spout Drop - 199mm



Tall &
Taller

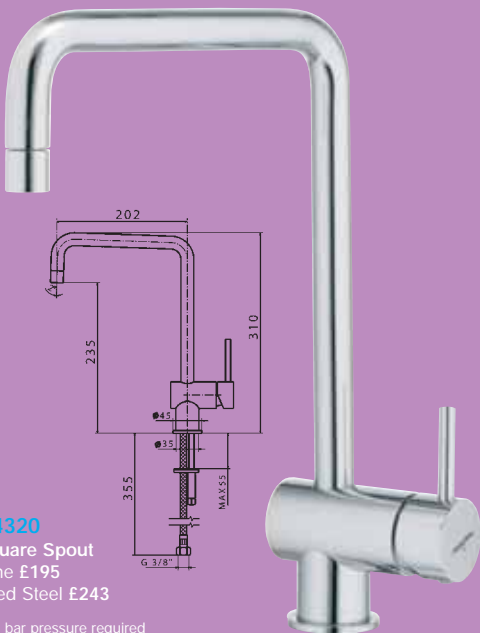

Ref. 4320

X-t Square Spout
Chrome £195
Brushed Steel £243

Min. 0.5 bar pressure required



Ref. 4325

X-t Round Spout
Chrome £195
Brushed Steel £243

Min. 0.5 bar pressure required



Ref. 2452
 Chrome Pull-out
 £345
 Brushed Steel Pull-out
 £422
 Min. 1.0 bar pressure required
 Height - 437mm
 Spout Reach - 219mm
 Spout Drop - 254mm



Ref. 2451
 Chrome Pull-out
 £354
 Brushed Steel Pull-out
 £434
 Min. 1.0 bar pressure required
 Height - 501mm
 Spout Reach - 219mm
 Spout Drop 318mm

X-t

These three delicately featured taps are manufactured by Newform to their usual uncompromising standards.



Ref. 4345
 X-t Pull-out
 Chrome £219
 Brushed Steel £275

Min. 1.0 bar pressure required



Water Pressure explained - page 119